



# *Digital-to-Analog Converter Box*



- Electronic Program Guide
- Parental Control / Caption / Text
- English / Spanish / French support
  - Auto Clock Setting

---

DAC-100 / DAC-200 /DAC-300

---

# IMPORTANT SAFETY INSTRUCTION

	<b>CAUTION</b> RISK OF ELECTRIC SHOCK DO NOT OPEN	
<b>CAUTION:</b> TO REDUCE THE RISK OF ELECTRIC SHOCK, DO NOT REMOVE COVER (OR BACK). NO USER-SERVICEABLE PARTS INSIDE. REFER SERVICING TO QUALIFIED SERVICE PERSONNEL.		



The lightning flash with arrowhead symbol, within an equilateral triangle, is intended to alert the user to the presence of uninsulated "dangerous voltage" within the product's enclosure that may be of sufficient magnitude to constitute a risk of electric shock.



The exclamation point within an equilateral triangle is intended to alert the user to the presence of important operating and servicing instructions in the literature accompanying the appliance.

<b>WARNING</b>	TO REDUCE THE RISK OF FIRE OR ELECTRIC SHOCK, DO NOT EXPOSE THIS APPLIANCE TO RAIN OR MOISTURE.
<b>CAUTION</b>	TO PREVENT ELECTRIC SHOCK, MATCH WIDE BLADE OF PLUG TO WIDE SLOT, FULLY INSERT.

**FCC NOTICE:** This equipment has been tested and found to comply with the limits for a Class B digital device, pursuant to part 15 of the FCC Rule. These limits are designed to provide reasonable protection against harmful interference in a residential installation. This equipment generates, uses and can radiate radio frequency energy and if not installed and used in accordance with the instructions, may cause harmful interference to radio communications. However, there is no guarantee that interference will not occur in a particular installation. If this equipment does cause harmful interference to radio or television reception; which can be determined by turning the equipment off and on, the user is encouraged to try to correct the interference by one or more of the following measures:

- Reorient or relocate the receiving antenna.
- Increase the separation between the equipment and receiver.
- Connect the equipment to an outlet on a circuit different from that to which the receiver is connected.
- Consult the dealer or an experience radio/TV technical for help.

This device complies with part 15 of the FCC Rules. Operation is subject to the following two conditions: (1) This device may not cause harmful interference, and (2) This device must accept any interference received, including interference that may cause undesired operation.

<b>CAUTION</b>	Any changes or modification in construction of this device which are not expressly approved by the party responsible for compliance could void the user's authority to operate the equipment.
----------------	---

- 1 Read these instructions.
- 2 Keep these instructions.
- 3 Heed all warnings.
- 4 Follow all instructions.
- 5 Do not use this apparatus near water.
- 6 Clean only with dry cloth.
- 7 Do not block any ventilation openings. Install in accordance with the manufacturer's instructions.
- 8 Do not install near any heat sources such as radiators, heat registers, stoves, or other apparatus (including amplifiers) that produce heat.
- 9 Do not defeat the safety purpose of the polarized or grounding-type plug. A polarized plug has two blades with one wider than the other. A grounding type plug has two blades and a third grounding prong. The wide blade or the third prong are provided for your safety. If the provided plug does not fit into your outlet, consult an electrician for replacement of the obsolete outlet.
- 10 Protect the power cord from being walked on or pinched particularly at plugs, convenience receptacles, and the point where they exit from the apparatus.
- 11 Only use attachments/accessories specified by the manufacturer.
- 12 Use only with the cart, stand, tripod, bracket, or table specified by the manufacturer, or sold with the apparatus. When a cart is used, use caution when moving the cart/apparatus combination to avoid injury from tip-over.
- 13 Unplug this apparatus during lightning storms or when unused for long periods of time.
- 14 Refer all servicing to qualified service personnel. Servicing is required when the apparatus has been damaged in any way, such as power-supply cord or plug is damaged, liquid has been spilled or objects have fallen into the apparatus, the apparatus has been exposed to rain or moisture, does not operate normally, or has been dropped.

# CONTENTS

## 1. PRODUCT INFORMATION

Important Safeguards .....	1
Contents .....	3
Read Carefully Before Using .....	4
Identification of Controls .....	5
Remote Control .....	6

## 4. BASIC OPERATION

Information Displays .....	30
Program and Station Guide .....	32
Normal Operation .....	33

## 2. INSTALLATION

Connecting to a TV .....	8
--------------------------	---

## 5. HELP

Specifications .....	34
Warranty .....	

## 3. SETUP

Menu Overview .....	9
Channel Menu Options .....	10
Option Menu Features .....	13
Lock Menu Options .....	22

# READ CAREFULLY BEFORE USING

Please read carefully before using this unit.

## Placement and handling

- The picture and sound of a nearby TV, VCR, or radio may be distorted. In this case, position the unit away from the TV, VCR, or radio.
- Do not use volatile liquids, such as insecticide spray, near the unit. Do not leave rubber or plastic products in contact with the unit for a long period of time. They will leave marks on the surface.

## When Not in Use

- When the unit is not in use, be sure to remove the disc or tape and turn off the power.
- If you do not use the unit for a long period of time, remove the remote control batteries to prevent leakage.

## Moving

- The original shipping carton and packing materials come in handy. For maximum protection, re-pack the unit as it was originally packaged at the factory.

## Cleaning

- Use a soft, dry cloth. If the surfaces are extremely dirty, use a soft cloth lightly moistened with a mild detergent solution. Do not use strong solvents such as alcohol, benzene, or thinner, as these might damage the surface of the unit.

## Maintenance

- This is a high precision video device. For optimal performance, we recommend regular inspection and maintenance every 1,000 hours by qualified service personnel. Contact your dealer or nearest service center.

## Antenna Orientation



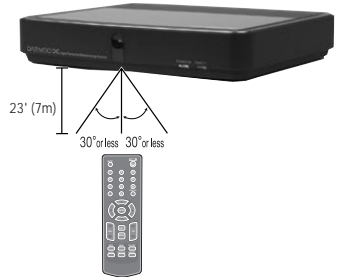

- Antennas are subject to changes in direction or damage due to wind and rain. For best results, contact your nearest service center about proper orientation and/or replacement.

## Using the Remote Control

- Operate remote control within 23 ft. (7m) of the unit.
- Do not press two buttons at the same time.
- Do not store in a dusty or humid location.



## Accessories

Remote Control & 1 Battery	RF Cable	Adaptor	Supporter (DAC-200 only)	Owner's Manual/ Warranty
				

- To purchase accessories or additional parts, contact your nearest dealer or service center.

# IDENTIFICATION OF CONTROLS

## Front Panel

DAC-100



Remote sensor  
Power indicator

DAC-300



Channel +/-  
Remote sensor  
Power indicator  
Power button

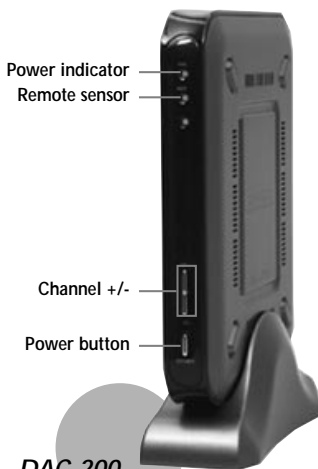

Power indicator  
Remote sensor

Channel +/-  
Power button





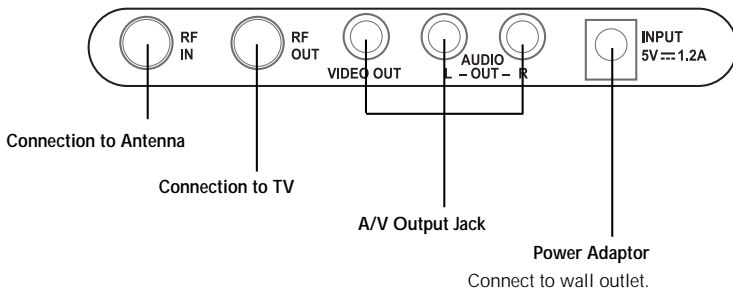











DAC-200

## Rear Panel



# REMOTE CONTROL



- 
- POWER**  
 POWER : Switches the receiver on or off.
- 
- MUTE**  
 MUTE : Turns sound ON and OFF
- 
- Numbers** : Chooses channels and enters programming information  
  
**Dash** : Enters a channel number for multiple program channels such as 2-1,2-2, etc
- 
- PRE-CH**  
 PRE-CH : Chooses previous channel
- 
- Navigation Buttons** : Selects options in a menu  

- 
- ENTER**  
 ENTER : Confirms a menu selection.
- 
- Volume** : Sets sound level  

- 
- Channel** : Selects channels in memory  

- 
- EXIT**  
 EXIT : Removes all on-screen displays and returns to TV viewing from any menu
- 
- MENU**  
 MENU : Accesses or closes main menu
- 
- EPG**  
 EPG : Brings up the Program Guide
- 
- INFO**  
 INFO : Shows the current station and program information on the screen
- 
- CH-LIST**  
 CH-LIST : Shows the all channels in memory
- 
- AUDIO**  
 AUDIO : Selects program's audio language or analog audio options if available
- 
- CAPTION**  
 CAPTION : Selects caption mode if available
- 
- ASPECT**  
 ASPECT : Selects TV-Ratio if available
-

**Digital-to-Analog Converter Box Remocon Code Table**

Format : M50560

NO	CUSTOM	DATA	Function
1	E8H	00H	0
2	E8H	01H	1
3	E8H	02H	2
4	E8H	03H	3
5	E8H	04H	4
6	E8H	05H	5
7	E8H	06H	6
8	E8H	07H	7
9	E8H	08H	8
10	E8H	09H	9
11	E8H	0AH	-
12	E8H	0DH	CAPTION
13	E8H	0FH	AUDIO
14	E8H	10H	MUTE
15	E8H	11H	ENTER
16	E8H	13H	VOL UP
17	E8H	14H	VOL DOWN
18	E8H	15H	STANDBY
19	E8H	17H	CH+
20	E8H	18H	CH-
21	E8H	19H	Right
22	E8H	1AH	Left
23	E8H	20H	PRE-CH
24	E8H	21H	INFO
25	E8H	22H	MENU
26	E8H	2CH	EPG
27	E8H	2DH	CH LIST
28	E8H	2EH	EXIT
29	E8H	30H	ASPECT
30	E8H	37H	Up
31	E8H	38H	Down



# CONNECTING TO A TV

- The default RF Output channel is Ch 4. And you can change it to Ch 3. See "Output Channel" on page 18.

## Various methods of connecting your TV

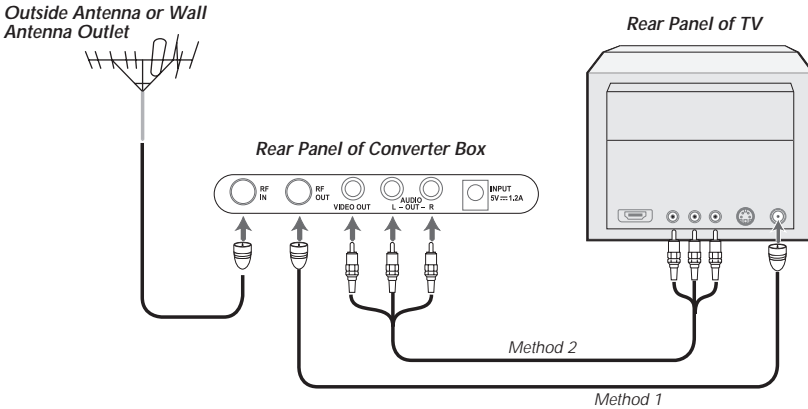

### Method 1

Unplug the RF cable from the "ANT.IN" Jack on the rear panel of the TV.

Plug this cable into the "RF IN" jack on the rear panel of the Converter Box.

Connect the "RF OUT" jack on the Converter Box to the "RF IN" jack on the TV with another RF cable.

### Method 2 : Connecting to a TV equipped with audio/video in jacks

Use the audio/video cable (*Not supplied*) to connect the "Video Out" jack on the Converter Box to the "Video In" jack on your TV.

Connect the "Audio Out" jack on the Converter Box to the "Audio In" jack on the TV.

Match the color of the cable to the color of the jack.

# MENU OVERVIEW

In this menu system, there are several ways to customize the menu settings provided. Most menus consist of three levels to set up the options, but some require greater depth for the variety of settings. If you press the [MENU] button, only the first and second level of the menu system will appear on the TV screen. The third level can be displayed by pressing [ENTER]. If a menu has more than three levels, the pop-up dialogue box will be displayed as the fourth or fifth level. For navigating the menu levels, you will see ► on the right side of the menu label to help you go to the next level.

## To show and remove the Menu:

Press the [MENU] button on the Remote Control to display the menu. A second press of the [MENU] button or a press of the [EXIT] button will take you back to TV viewing.

## To go to the next level:

Press ► on the Remote Control.

## To go back to the previous level:

Press [MENU] (or ◀) on the Remote Control.

## Typical Menu Operation

### 1 Press [MENU].

The main menu will appear.

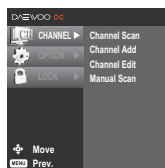

### 2 Use [▲▼] to select the desired menu option.

### 3 While the desired menu option is selected, press [►] or [ENTER] to move to the second level.

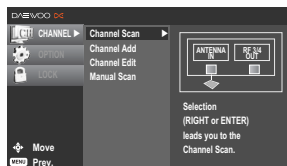

### 4 Use [▲▼] to select the second menu option.

### 5 Press [►] or [ENTER] to move to the third level.

Some menu options require additional steps.

### 6 Press [MENU] to return to the previous menu or press [EXIT] on the Remote Control to return to TV viewing.

# CHANNEL MENU OPTIONS

## Channel Scan

Automatically finds all channels available through the 'RF IN' source. The unit stores all the active channels found, on the channel list. Inactive or weak channels may not appear on the list. In that case, add missing channels manually with the Manual Scan menu.

The channel list created here can be seen in the Channel Edit menu.

- 1 Press [MENU] to display the on-screen menu.
- 2 Select the SETUP menu using [▲▼] then press [ENTER] or [▶] to move to the second level.
- 3 Select the "Channel Scan" using [▲▼] then press [ENTER] or [▶] .

- 4 Press [ENTER].

The channel search process begins.

You can skip the current scanning by pressing [ENTER].

You can stop the process by pressing [MENU] or [EXIT].

- 5 After the channel search is complete, the lowest channel number found appears on the TV screen.

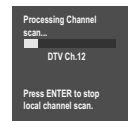
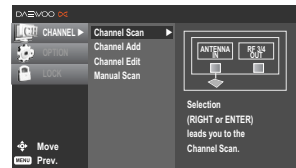
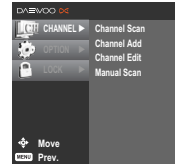

## Channel Add

Automatically adds new channels available through the antenna input (RF IN) except memorized channels already in the channel list.

- 1 Press [MENU] to display the on-screen menu.
- 2 Select the SETUP menu using [▲▼] then press [ENTER] or [▶] to move to the second level.
- 3 Select the "Channel Add" using [▲▼] then press [ENTER] or [▶].  
Channel Add channel search process begins.  
You can skip the current scanning by pressing [ENTER].  
You can stop the process by pressing [MENU] or [EXIT].
- 4 After Channel Add search is complete, the lowest channel number found appears on the TV screen.

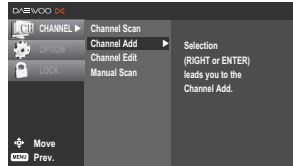

## Channel Edit

Channel Edit allows you to manually add or delete channels from the channel list in memory and create your own surf list of favorite channels.

- 1 Press [MENU] to display the on-screen menu.
- 2 Select the SETUP menu using [▲▼] then press [ENTER] or [▶] to move to the second level.
- 3 Select the "Channel Edit" using [▲▼] then press [ENTER] or [▶].  
Channel Edit menu appears.  
**To add or delete a channel:**  
Press [ENTER] to add or delete the channel on the channel editing menu.
- 4 Press [MENU] to return to the previous menu or press [EXIT] on the Remote Control to return to TV viewing.

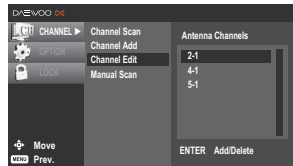
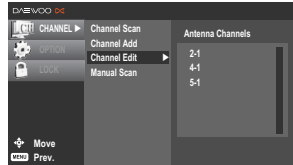

### NOTES

Deleted channels can not be selected with the CH (+/-) buttons.

## Manual Scan

This feature manually adds or deletes channels.

- 1 Press [MENU] to display the on-screen menu.
- 2 Select the SETUP menu using [▲▼] then press [ENTER] or [▶] to move to the second level.
- 3 Select the "Manual Scan" using [▲▼] then press [ENTER] or [▶] .  
Manual Add menu appears.
- 4 Select a channel to add or delete using [▲▼] or the numbered buttons.
- 5 Press [ENTER] to confirm your selection.
- 6 Repeat steps 4-5 to add or delete additional channels with the Manual Scan menu.
- 7 Press [MENU] to return to the previous menu or press [EXIT] on the Remote Control to return to TV viewing.

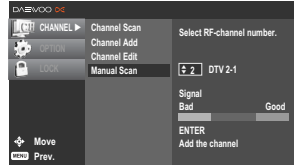
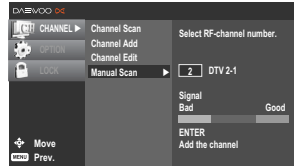

# OPTION MENU FEATURES

## Clock

Enables the user to set up the clock information. Normally, your clock is set using signals transmitted by DTV stations. Choosing your time zone sets the current time automatically.

- 1 Press [MENU] to display the on-screen menu.
- 2 Select the OPTION menu using [▲▼] then press [ENTER] or [▶] to move to the second level.
- 3 Use [▲▼] to select the Clock option then press [▶] or [ENTER] to move to the third level.
- 4 Use [◀▶] to set Time Zone: (Hawaii, New F.land, Atlantic, Eastern, Central, Mountain, Pacific, Alaska)
- 5 Press [MENU] to return to the previous menu or press [EXIT] on the Remote Control to return to TV viewing.

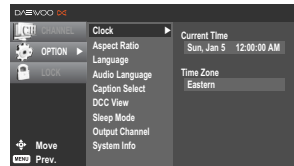

### NOTES

*There are cases where the TV station does not send, or sends wrong date and/or time information causing the Converter Box to set an incorrect time.*

## Aspect Ratio

Selects the screen format. To view a picture with a wide (16:9) aspect ratio, you can choose Set By Program, Letter Box, Cropped, or Squeezed.

- 1 Press [MENU] to display the on-screen menu.
- 2 Select the OPTION menu using [▲▼] then press [ENTER] or [▶] to move to the second level.
- 3 Use [▲▼] to select the Aspect Ratio option.
- 4 Press [▶] or [ENTER] to move to the third level.
- 5 Use [▲▼] to select an option then press [ENTER] to confirm your selection.
- 6 Press [MENU] to return to the previous menu or press [EXIT] on the Remote Control to return to TV viewing.

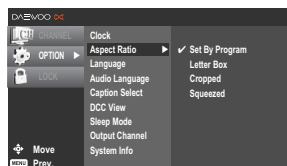

Options to view a picture with a wide (16:9) aspect ratio at 480i or 480p mode output format.

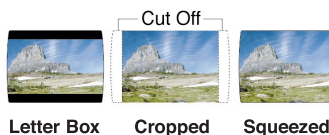

### TIP

While watching TV, you can change the picture aspect ratio using [ASPECT] on the Remote Control.

## Aspect Ratio Descriptions

### Use the [ASPECT] button to choose Aspect Ratios

#### Aspect Ratios available for viewing high definition content

##### Set By Program

Aspect Ratio is set by program.

##### Letter Box

Use for a picture with an original 16:9 aspect ratio (in a wide format). Letterbox mode will shrink the picture to fill the screen, with black/gray (or blank) bars appearing at the top and bottom of the screen.

##### Cropped

Use for a picture filling the entire screen by cropping (removing) the left and right portions of the picture.

##### Squeezed

Use for a full picture filling the entire screen with no black/gray bars. The picture in a 16:9 format will be horizontally adjusted or squeezed to fit the 4:3 ratio Monitor. This setting can also be useful when used with 16:9 aspect ratio monitors or with 4:3 aspect ratio Monitors that have a "16:9 enhancement" feature.

## Menu Language

Select a language for the menus to appear in.

- 1 Press [MENU] to display the on-screen menu.
- 2 Select the OPTION menu using [▲▼] then press [ENTER] or [▶] to move to the second level.
- 3 Select the Language option using [▲▼].
- 4 Press [▶] or [ENTER] to move to the third level.
- 5 Select the desired language using [▲▼] then press [ENTER] to confirm your selection.
- 6 Press [MENU] to return to the previous menu or press [EXIT] on the Remote Control to return to TV viewing.

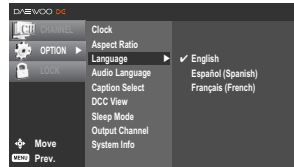



## Audio Language

Digital channels sometimes provide multiple audio tracks, often in a different language. You can set a default audio language with the Audio Language menu.

- 1 Press [MENU] to display the on-screen menu.
- 2 Select the OPTION menu using [▲▼] then press [ENTER] or [▶] to move to the second level.
- 3 Select the Audio Language option using [▲▼].
- 4 Press [▶] or [ENTER] to move to the third level.
- 5 Select the desired language using [▲▼] then press [ENTER] to confirm your selection.
- 6 Press [MENU] to return to the previous menu or press [EXIT] on the Remote Control to return to TV viewing.

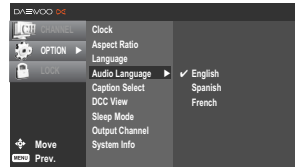

### TIP

- If provided by the broadcaster, you can also select a different audio language while viewing TV by pressing AUDIO repeatedly.
- If multiple audio tracks are available, the audio icon appears on the program information display or Program guide. You can select one of the other languages with the AUDIO button.

## Captions Select

- 1 Press [MENU] to display the on-screen menu.
- 2 Select the OPTION menu using [▲▼] then press [ENTER] or [▶] to move to the second level.
- 3 Select the Caption Select option using [▲▼].
- 4 Press [▶] or [ENTER] to move to the third level.
- 5 Select the desired Caption using [▲▼] then press [ENTER] to confirm your selection.
- 6 Press [MENU] to return to the previous menu or press [EXIT] on the Remote Control to return to TV viewing.

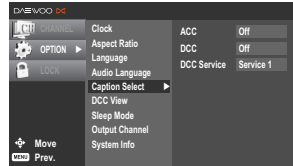

### ACC (Analog Captions)

Allows you to select a mode for displaying Analog Caption Data. In the Analog Caption Service, Caption 1-4 display program's dialog, and Text 1-4 display data service information.

#### NOTES

Analog Captions will appear if they are provided by the broadcaster.

#### Off

Analog Caption is not displayed.

#### Caption 1

Caption 1 is the primary caption service that synchronizes the captioning language with the sound, used by most broadcasters. Captioning is displayed in the same language as the program's dialog.

#### Caption 2

Caption 2 is the special non-synchronous caption service that does not need to be in sync with the sound and may provide simplified captioning, which is usually delayed.

#### Caption 3

Caption 3 serves as an alternate captioning service channel. Captioning is often a secondary language translation such as French, Spanish, simplified English or displayed at a slower rate.

#### Caption 4

Caption 4 is another special non-synchronous caption service that does not need to be in sync with the sound and may provide simplified captioning, usually delayed.

#### Text 1 - 4

Text 1-4 usually displays information on the lower portion of the screen and is used for a data service, generally not program related.

#### TIP

If available, press [CAPTION] repeatedly to select a caption language while viewing TV.

#### NOTES

If DTV and Analog Caption are received simultaneously, you can only select DTV Captions, analog captions will not appear.

**DCC (DTV Captions)**

Selects a default Caption language.

Off

DTV Caption is not displayed.

Custom

Set DTV Captions by user

Standard

Set DTV Captions by program

**NOTES**

---

- DTV Caption (Standard EIA /CEA 708) will appear only if provided by the broadcaster.
- If DTV and Analog Captions are received simultaneously, you can only select DTV Caption.

**TIP**

---

- If available, you can also select a caption language while viewing TV, press CC repeatedly.
- If captions are available, the DTV caption icon appears on the program information display, Program Guide, or Station Guide to indicate that you can select one of those caption options with the CC button. The caption icon will not appear on the program information display or Program Guide for analog caption.

**DCC Service (DTV Captions)**

Selects a default Caption language

Service 1

Service1 language is selected for DTV captions

Service 2

Service2 language is selected for DTV captions

Service 3

Service3 language is selected for DTV captions

Service 4

Service4 language is selected for DTV captions

Service 5

Service5 language is selected for DTV captions

Service 6

Service6 language is selected for DTV captions

## DCC View

- 1 Press [MENU] to display the on-screen menu.
- 2 Select the OPTION menu using [▲▼] then press [ENTER] or [▶] to move to the second level.
- 3 Select the DCC View option using [▲▼].
- 4 Press [▶] or [ENTER] to move to the third level.
- 5 Select the desired setup using [▲▼] then press [ENTER] to confirm your selection.
- 6 Press [MENU] to return to the previous menu or press [EXIT] on the Remote Control to return to TV viewing.

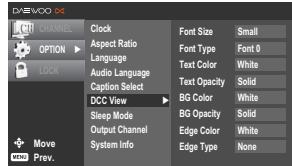

### DTV Caption Style

Selects DTV Captions appearance menu options.

#### Font Size

Selects the font size for captions.

Standard: The standard text size is used for the caption display (15 pixels).

Large: The large text size is used for the caption display (21 pixels).

Small: The small text size is used for the caption display (11 pixels).

#### Font Type

Selects the font type for captions.

#### Text Color

Selects the font color for captions.

#### Text Opacity

Selects the font opacity for captions.

Solid: The text is solid (without any transparency).

Flash: The text blinks twice a second.

Translucent: The text is translucent.

Transparent: The text is transparent (In this case, whatever the color is, the color does not affect the captions display).

#### BG Color

Selects the background color for captions.

#### BG Opacity

Selects the background opacity for captions.

Solid: The text background color is solid (without any transparency).

Flash: The text background color blinks twice a second.

Translucent: The text background color is translucent.

Transparent: The text background color is transparent (In this case, whatever the background color is, the color does not affect the captions.).

#### Edge Color

Selects the edge color for captions (If the edge type is selected as None, the edge color does not have any effect on the captions display).

### Edge Type

Selects the edge type for captions.

None: The text has no edge.

Uniform: The text has a uniform edge.

Raised: The text is raised.

Depressed: The text is depressed.

Left Shadow: The text has a left-shadow edge.

Right Shadow: The text has a right-shadow edge.

## Sleep Mode

Use this option to change the Converter Box's sleep mode time. The default is 4 hours.

- 1 Press [MENU] to display the on-screen menu.
- 2 Select the OPTION menu using [▲▼] then press [ENTER] or [▶] to move to the second level.
- 3 Select the Sleep Mode option using [▲▼].
- 4 Press [▶] or [ENTER] to move to the third level.
- 5 Select the desired sleep mode using [▲▼] then press [ENTER] to confirm your selection.
- 6 Press [MENU] to return to the previous menu or press [EXIT] on the Remote Control to return to TV viewing.

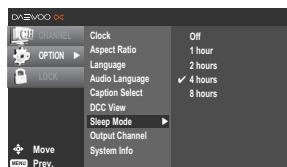

### NOTES

- If you have no input in selected time, the Converter Box will be turn off on selected time.
- If you have selected "Off", the Converter Box is not turn off automatically.

## Output Channel

Use this option to change the Converter Box's output channel. The default is channel 4.

- 1 Press [MENU] to display the on-screen menu.
- 2 Select the OPTION menu using [▲▼] then press [ENTER] or [▶] to move to the second level.
- 3 Select the Output Channel option using [▲▼].
- 4 Press [▶] or [ENTER] to move to the third level.
- 5 Select the desired output channel using [▲▼] then press [ENTER] to confirm your selection.
- 6 Press [MENU] to return to the previous menu or press [EXIT] on the Remote Control to return to TV viewing.

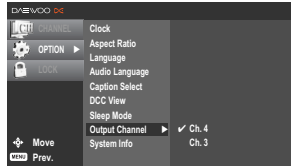

## System Information

You can see the firmware version.

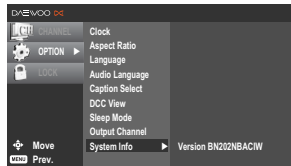

# LOCK MENU OPTIONS

## Lock System

Allows you to set up specific channels and ratings through blocking schemes. Also allows you to activate or disable all of the lock schemes previously set up. A password is required to gain access to the LOCK menus. If the Lock System is set to Off, the Channel and Program Ratings are not functional.

- 1 Press [MENU] to display the on-screen menu.
- 2 Select the LOCK menu using [▲▼] then press [ENTER] or [▶] to move to the second level.

### If you have not entered a password yet:

Key-in the "0000" password using the numbered buttons to create a per-sonal 4-digit security password.

### If you have already entered a password:

Key-in the 4-digit password using the numbered buttons to confirm the personal 4-digit security password.

- 3 Select the Lock System option using [▲▼].
- 4 Press [▶] or [ENTER] to move to the third level.
- 5 Select an option (On or Off) using [▲▼] then press [ENTER] to confirm your selection.
- 6 Press [MENU] to return to the previous menu or press [EXIT] on the Remote Control to return to TV viewing.

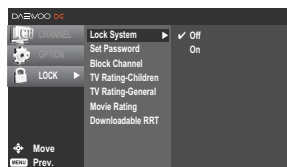
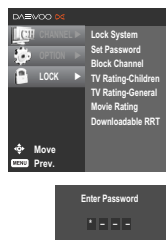

## Set Password

Changes the password.

- 1 Follow steps 1-2 as shown above (Lock System).
- 2 Select the Set Password option using [▲▼].
- 3 Press [▶] or [ENTER] to move to the third level.
- 4 Enter the new 4-digit password.
- 5 Enter the same password again.
- 6 Press [MENU] to return to the previous menu or press [EXIT] on the Remote Control to return to TV viewing.

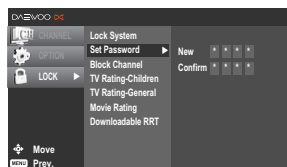

## Block Channel

Blocks any channel that you do not want to view or that you do not want your children to watch. If you tune in a blocked channel, a black screen with a pop-up box will appear. Block Ch can override Channel Edit menu settings (see page 20).

- 1 Press [MENU] to display the on-screen menu.
- 2 Select the LOCK menu using [▲▼] then press [ENTER] or [▶] to move to the second level.

### If you have not entered a password yet:

Key-in the "0000" password using the numbered buttons to create a personal 4-digit security password.

### If you have already entered a password:

Key-in the 4-digit password using the numbered buttons to confirm the personal 4-digit security password.

- 3 Select the Block Channel option using [▲▼].

The channel list menu appears.

### To lock or unlock a channel:

Use (SELECT) to block or unblock the channel on the block channel menu.

The mark  will appear to the right of the station name to indicate the blocked channel.

- 4 Repeat step 2 to block or unblock additional channels on the channel list menu.
- 5 Press [MENU] to return to the previous menu or press [EXIT] on the Remote Control to return to TV viewing.

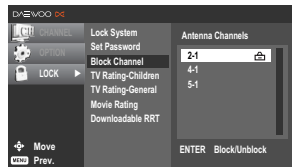
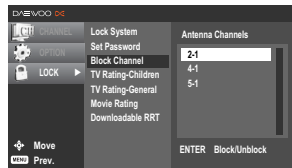
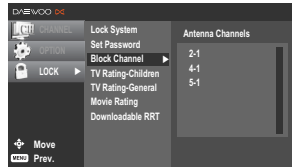



## TV Rating-Children

Prevents children from watching certain children’s TV programs according to the ratings limit set. This rating applies only to TV programs for children. Unless you block TV programs intended for mature audiences in the TV Rating – General menu, your children could view those programs.

- 1 Press [MENU] to display the on-screen menu.
- 2 Select the LOCK menu using [▲▼] then press [ENTER] or [▶] to move to the second level.

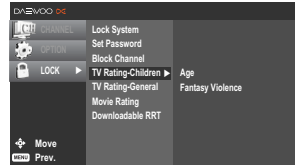

### If you have not entered a password yet:

Key-in the “0000” password using the numbered buttons to create a personal 4-digit security password.

### If you have already entered a password:

Key-in the 4-digit password using the numbered buttons to confirm the personal 4-digit security password.

- 3 Select the TV Rating-Children option using [▲▼].
- 4 Press [▶] or [ENTER] to move to the third level.
- 5 Select the Age or Fantasy Violence option using [▲▼] then press [ENTER] to confirm your selection.

### Age :

Selection applies regardless of content category of rating.

### Fantasy Violence :

Selection applies if TV programs include rating for Fantasy Violence.

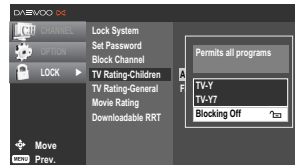

- 6 Select a rating using [▲▼] then press [ENTER] to confirm your selection.

**Blocking Off :** All programs with a rating are blocked.

**TV-Y :** All Children.

This program is designed to be appropriate for all children. Whether animated or live-action, the themes and elements in this program are specifically designed for a very young audience, including children from ages 2 - 6. This program is not expected to frighten younger children.

**TV-Y7 :** Directed toward children age 7 and older.

This program is designed for children age 7 and older. It may be more appropriate for children who have acquired the developmental skills needed to distinguish between make-believe and reality. Themes and elements in this program may include mild fantasy violence or comedic violence, or may frighten children under the age of 7. Therefore, parents may wish to consider the suitability of this pro-gram for their very young children.

Note: For those programs where fantasy violence may be more intense or more combative than other programs in this category, such programs will be designated TV-Y7-FV.

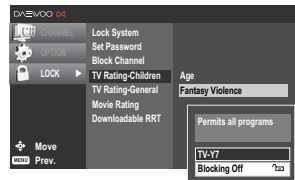

- Press [MENU] to return to the previous menu or press [EXIT] on the Remote Control to return to TV viewing.

## TV Rating-General

Blocks TV programs that you or your family may not wish to watch, based on the rating scheme set.

- Press [MENU] to display the on-screen menu.
- Select the LOCK menu using [▲▼] then press [ENTER] or [▶] to move to the second level.

### If you have not entered a password yet:

Key-in the "0000" password using the numbered buttons to create a personal 4-digit security password.

### If you have already entered a password:

Key-in the 4-digit password using the numbered buttons to confirm the personal 4-digit security password.

- Select the TV Rating-General option using [▲▼].
- Press [▶] or [ENTER] to move to the third level.
- Select the Age, Dialogue, Language, Sex, or Violence option using [▲▼] then press [ENTER] to confirm your selection.

### Age :

Selection applies regardless of content category of rating.

### Dialogue :

Selection applies if TV programs have rating for Dialogue.

### Language :

Selection applies if TV programs have rating for Language.

### Sex :

Selection applies if TV programs have rating for Sex.

### Violence :

Selection applies if TV programs have rating for Violence.

- Select a rating using [▲▼] then press [ENTER] to confirm your selection.

**Blocking Off** : All programs with a ratings are blocked.

**TV-G** : General Audience.

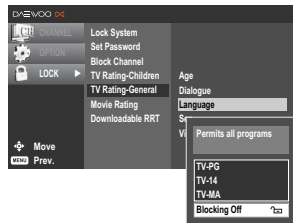
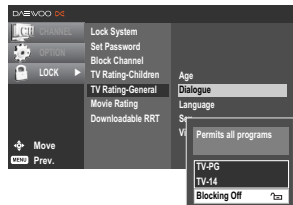
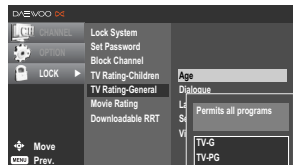
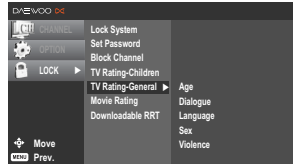

Most parents would find this program suitable for all ages. Although this rating does not signify a program designed specifically for children, most parents may let younger children watch this program unattended. It contains little or no violence, no strong language and little or no sexual dialogue or situations.

**TV-PG** : Parental Guidance Suggested.

This program contains material that parents may find unsuitable for younger children. Many parents may want to watch it with their younger children. The theme itself may call for parental guidance and/or the program contains one or more of the following: moderate violence (V), some sexual situations (S), infrequent coarse language (L), or some suggestive dialogue (D).

**TV-14** : Parents Strongly Cautioned.

This program contains some material that many parents would find unsuitable for children under 14 years of age. Parents are strongly urged to exercise greater care in monitoring this program and are cautioned against letting children under the age of 14 watch unattended.

This program contains one or more of the following: intense violence (V), intense sexual situations (S), strong coarse language (L), or intensely suggestive dialogue (D).

**TV-MA** : Mature Audience Only.

This program is specifically designed to be viewed by adults and therefore may be unsuitable for children under 17. This program contains one or more of the following: graphic violence (V), explicit sexual activity (S), or crude indecent language (L).

- 7 Press [MENU] to return to the previous menu or press [EXIT] on the Remote Control to return to TV viewing.

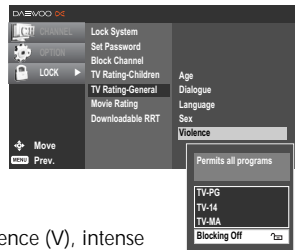
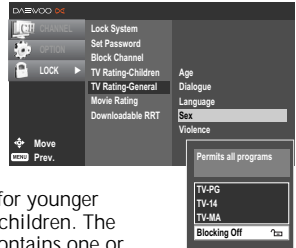

## Movie Rating

Blocks movies according to the movie ratings restrictions so children cannot view certain movies. You can set the ratings to block out all the movies with ratings above a specified level. Keep in mind that the movie ratings apply only to movies shown on TV, not TV programs such as soap operas.

- 1 Press [MENU] to display the on-screen menu.
- 2 Select the LOCK menu using [▲▼] then press [ENTER] or [▶] to move to the second level.

### If you have not entered a password yet:

Key-in the "0000" password using the numbered buttons to create a personal 4-digit security password.

### If you have already entered a password:

Key-in the 4-digit password using the numbered buttons to confirm the personal 4-digit security password.

- 3 Select the Movie Rating option using [▲▼].
- 4 Press [▶] or [ENTER] to move to the third level.
- 5 Select a rating using [▲▼] then press [ENTER] to confirm your selection.

**Blocking Off** : All programs with a rating are blocked.

**G** : (General Audiences) Content is not offensive to most viewers.

This is a film which contains nothing in theme, language, nudity and sex, violence, etc. which would be offensive to parents whose younger children view the film. The G rating is not a "certificate of approval," nor does it signify a children's film. Some snippets of language may go beyond polite conversation but they are common everyday expressions. No stronger words are present in G-rated films. The violence is at a minimum. Nudity and sex scenes are not present; nor is there any drug use content.

**PG** : Parental Guidance Suggested. Some Material May Not Be Suitable For Children

The PG rating, suggesting parental guidance, is an alert for examination of a film by parents before deciding on its viewing by their children. This is a film which clearly needs to be examined or inquired into by parents before they let their children see it. The label PG plainly states that parents may consider some material unsuitable for their children, but the parent must make the decision. Parents are warned against allowing their children to see PG-rated movies. The theme of a PG-rated film may itself call for parental guidance. There may be some profanity in these films. There may be some violence or brief nudity. But these elements are not deemed so intense as to require that parents be strongly cautioned beyond the suggestion of parental guidance. There is no drug use content in a PG-rated film.

**PG-13** : PG-13 Parents Strongly Cautioned. Some Material May Be Inappropriate For Children Under 13

PG-13 is a sterner warning to parents to determine for themselves the attendance in particular of their younger children as they might consider some material not suited for them. Parents, by the rating, are alerted to be very careful about viewing by their underage children. A PG-13 film is one which leaps beyond the boundaries of the PG rating in theme, violence, nudity, sensuality, language, or other contents, but does not quite fit within the restricted R category. Any drug use

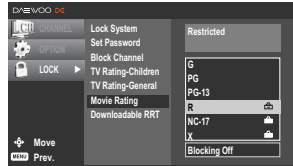
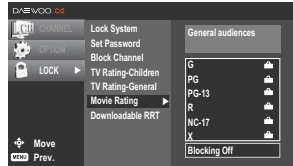

content will initially require at least a PG-13 rating. In effect, the PG-13 cautions parents with more stringency than usual to give special attention to this film before they allow their 12-year olds and younger to see it. PG-13 places larger responsibilities on parents for their children's movie viewing. The rating system is not a surrogate parent, nor should it be. It cannot, and should not, insert itself in family decisions that only parents can, and should, make. Its purpose is to give prescreening advance informational warnings, so that parents can form their own judgments. PG-13 is designed to make these parental decisions easier for films between PG and R.

**R** : (Restricted viewing) Not for children under age 17. Strong elements of sex and/or violence. Requires Accompanying Parent Or Adult Guardian. The film definitely contains some adult material. Parents are strongly urged to find out more about the film before they allow their children to see it. An R-rated film may include hard language, or tough violence, or nudity within sensual scenes, or drug abuse or other elements, or a combination of some of the above, so that parents are counseled, in advance, to take this advisory rating very seriously. Parents must find out more about an R-rated movie before they allow their teenagers to view it.

**NC-17** : (Restricted Viewing) Not for children under age 17 under any circumstances. Strong sexual content.

This rating declares that this is a film that most parents will consider patently too adult for their youngsters under 17. No children should see the film. NC-17 does not necessarily mean "obscene or pornographic" in the oft-accepted or legal meaning of those words. The reasons for the application of an NC-17 rating can be violence or sex or aberrational behavior or drug abuse or any other elements which, when present, most parents would consider too strong and therefore off-limits for viewing by their children.

**X** : (Hard Core Films) Same as NC-17 rating.

- 6 Press [MENU] to return to the previous menu or press [EXIT] on the Remote Control to return to TV viewing.**

## Downloadable RRT

You can block TV program with downloadable region rating table.

- 1 Press [MENU] to display the on-screen menu.
- 2 Select the LOCK menu using [▲▼] then press [ENTER] or [▶] to move to the second level.

### If you have not entered a password yet:

Key-in the "0000" password using the numbered buttons to create a personal 4-digit security password.

### If you have already entered a password:

Key-in the 4-digit password using the numbered buttons to confirm the personal 4-digit security password.

- 3 Select the Downloadable RRT option using [▲▼].
- 4 Press [▶] or [ENTER] to move to the third level.
- 5 Select the Rating Value option using [▲▼] then press [ENTER] to confirm your selection.

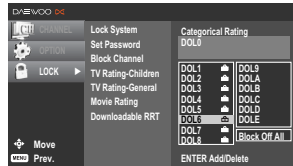
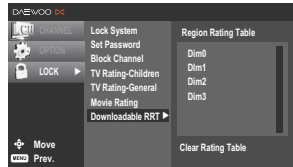
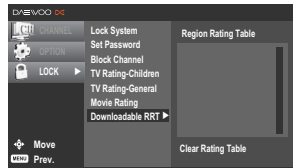

# INFORMATION DISPLAYS

## Channel Banner Display

The Channel Banner appears whenever you tune to a new channel or press the [ENTER] button on the Remote Control while viewing a program.



### 1 Press [ENTER] while watching a program.

The Channel Banner appears on the TV screen (Channel number, audio, station name, and current time).

- The Channel Banner can be seen displayed on the TV screen for a moment.

#### a. Channel Number

Displays the current channel number.

#### b. Station Name

Displays the station name of the current channel.

#### c. Block Information

Displays the block information such as No Signal, Rating Blocked, Channel Blocked, Audio Only or Scrambled.

#### d. Time

Displays the current time.

### 2 Press [ENTER] again while the Channel Banner is displayed.

The Channel Banner disappears from the TV screen.

#### NOTES

- Station name and clock are displayed only if they are provided by broad-caster.
- If the channel is scrambled, you may not be able to see the program.

**Program Information Display**

The Program Information Display appears if you press the [INFO] button on the Remote Control while viewing a program.



**1 Press [INFO] while watching a program.**

Program Information appears on the TV screen.

- a. Program Title  
Indicates title of current program.
- b. Date  
Displays the current date.
- c. Start Time and End Time  
Displays the start time and end time for the current program.
- d. Time  
Shows current time.
- e. Channel Number  
Displays the current channel number.
- f. Station Name  
Displays the station name of the current channel.
- g. Multiple Audio Icon  
Channels sometimes provide multiple audio tracks, often in a different language. When multiple audio tracks are available, the Multiple Audio Icon is displayed that you can select one of those other audio tracks with the AUDIO button.
- h. DTV Caption Icon  
Indicates that the current program contains Digital Closed Caption Data Service.
- i. Wide Icon  
Indicates that the current program is shown in wide picture format.

**2 Press [INFO] or [EXIT] while the Program Information is displayed.**

The Program Information disappears from the TV screen.

**NOTES**

*Station name and clock are displayed only if they are provided by the broad-caster.*



# PROGRAM AND STATION GUIDE

The Program and Station Guide contains schedule and program information for all channels. They also provide local over-the-air channels information including conventional digital channels. Use the Program and Station Guide to find programs easily and conveniently and to view schedule and descriptive program information for the channels.

## To Display the Program or Station Guide

Press the [EPG] button on your Remote Control.

## To Exit the Program or Station Guide

Press the [EXIT] button to return to the last channel you tuned to.

## To Navigate through programs on the Guides

The Program and Station Guide are operated based on a simple straightforward "Highlight and Select" process.

1. Use [◀▶] on your Remote Control to navigate the guide screen.
2. Press [ENTER] to select or execute the highlighted menu or function.



# NORMAL OPERATION

## Channel Selection

You can select channels as described below.

### Number and – (dash) buttons (on the Remote Control)

Use Number (0-9) and – (dash) buttons to select a channel directly.

### [CH +/-] buttons (on the Remote Control) or [▲▼] (on the front panel)

Use [CH +/-] on the Remote Control or [▲▼] on the front panel to cycle the Converter Box through the channels in memory.

## Volume Adjustment

Adjusts the sound level for analog audio out on the HDTV Receiver. You must set Audio Variable to On in the OPTION menu to use the Volume Adjustment.

### [VOL +/-] buttons (on the Remote Control) or [◀▶] (on the front panel)

Use [VOL +/-] on the Remote Control or [◀▶] on the front panel to adjust the sound level for analog audio out on the Converter Box.

### MUTE (on the Remote Control)

Press [MUTE] to turn off the volume for audio out on the Converter Box.

#### NOTES

*Before setting Audio Variable to Off, make sure that you have turned down the TV's volume to the minimum. Otherwise, sudden high volume sound may cause hearing or speaker damage.*

# SPECIFICATION

Television System	Fully ATSC Compliant
Channel Coverage	Terrestrial : 2 ~ 69
ATSC RF input	RF IN (1)
RF Output	3 / 4 Channel
Video Output	480i Composite
Audio Output	Analog Audio (L/ R)
Dimension (DAC-100)	180 x 150 x 30 (mm <sup>3</sup> )
Weight (DAC-100)	~290 g
Power Requirements	AC 120V, 60Hz
Power Consumption	In standby : 1.6W Operating : 8W
Accessories	RF Cable, Remote Control, Batteries

# LIMITED WARRANTY

This limited warranty begins on the original date of purchase, and is valid only on products purchased and used in the United States. Your DAEWOO product will be repaired or replaced, at DAEWOO's option, if it proves to be defective in material or workmanship under normal use, during the warranty period set forth below. This limited warranty is good only to the original purchaser of the product and effective only when used in the United States, including Hawaii, and U.S. Territories.

## WARRANTY PERIOD :

**LABOR** : 90 days from the Date of Purchase.

**PART** : 90 days from the Date of Purchase.

Replacement Units and Repair Parts may be new or factory remanufactured.

Replacement Units and Repair Parts are warranted for the remaining portion of the original unit's warranty period.

## HOW SERVICE IS HANDLED :

The original dated bill of sale must be presented upon request as proof of purchase to DAEWOO or DAEWOO authorized service center. Shipping costs of the product to and from the service center or DAEWOO factory Service is the responsibility of the purchaser.

**THIS WARRANTY IS IN LIEU OF ANY OTHER WARRANTY, EXPRESS OR IMPLIED, INCLUDING WITHOUT LIMITATION, ANY WARRANTY OF MERCHANTABILITY OR FITNESS FOR A PARTICULAR PURPOSE.**

**TO THE EXTENT ANY IMPLIED WARRANTY IS REQUIRED BY LAW, IT IS LIMITED IN DURATION TO THE EXPRESS WARRANTY PERIOD ABOVE.**

**NEITHER THE MANUFACTURER NOR ITS U.S. DISTRIBUTOR SHALL BE LIABLE FOR ANY INCIDENTAL CONSEQUENTIAL, INDIRECT, SPECIAL, OR PUNITIVE DAMAGES OF ANY NATURE.**

**INCLUDING WITHOUT LIMITATION, LOST REVENUES OR PRO PROFITS, OR ANY OTHER DAMAGE WHETHER BASED IN CONTRACT, TORT, OR OTHERWISE.**

Some states do not allow the exclusion or limitation of incidental or consequential damages or limitations on how an implied warranty lasts, so the above exclusion or limitation may not apply to you. This warranty gives you specific legal rights and you may also have other rights that vary from state to state.

## THIS LIMITED WARRANTY DOES NOT APPLY TO :

Service trips to your home to deliver, pick up, and/or install the product, instruct, or replace or correct wiring, or correction of unauthorized repairs.

Damages or operating problem that result from misuse, abuse, operation outside environmental specifications or contrary to the requirements of precautions in the Operating Guide, accident, vermin, fire, flood, improper installation, acts of God, unauthorized modification or alteration, incorrect electrical current or voltage, or commercial use, or use for other than intended purpose.

The cost of repair or replacement under these excluded circumstances shall be borne by the consumer.

## CUSTOMER INTERACTIVE CALL CENTER NUMBER

To obtain Customer Assistance, or Authorized Service Center location:

**Call 1-877-393-7823(1-877-DWESVC3)** and select the appropriate option from the menu. **Or visit our website : <http://www.e-daewoo.com>**

## TO CONTACT DAEWOO ELECTRONICS BY MAIL:

DAEWOO Customer Service

300-3E State Route 17 South Lodi, NJ 07644

**Model : DAC-100/DAC-200/DAC-300**



The CSA US mark indicates that a product meets applicable U.S. standards, including those from ANSI, ASME, ASSE, ASTM, NSF, CSA America and UL.

**Daewoo Electronics America Inc.**